

SPE 37907

## Disposal of Dirty Liquids Using Slurry Fracture Injection

Maurice B. Dusseault, SPE, Roman A. Bilak, SPE, Terralog Technologies Inc. and L. Gene Rodwell, Rodwell & Associates Ltd.

Copyright 1997, Society of Petroleum Engineers, Inc.

This paper was prepared for presentation at the 1997 SPE/EPA Exploration and Production Environmental Conference held in Dallas, Texas, 3-5 March 1997.

This paper was selected for presentation by an SPE Program Committee following review of information contained in an abstract submitted by the author(s). Contents of the paper, as presented, have not been reviewed by the Society of Petroleum Engineers and are subject to correction by the author(s). The material, as presented, does not necessarily reflect any position of the Society of Petroleum Engineers, its officers, or members. Papers presented at SPE meetings are subject to publication review by Editorial Committees of the Society of Petroleum Engineers. Electronic reproduction, distribution, or storage of any part of this paper for commercial purposes without the written consent of the Society of Petroleum Engineers is prohibited. Permission to reproduce in print is restricted to an abstract of not more than 300 words; illustrations may not be copied. The abstract must contain conspicuous acknowledgment of where and by whom the paper was presented. Write Librarian, SPE, P.O. Box 833836, Richardson, TX 75083-3836, U.S.A., fax 01-972-952-9435.

### Abstract

An automated waste liquid injection system for dirty liquids was designed and implemented in an unconsolidated sandstone formation in southeastern Alberta. This development was based on previous waste sand injection in central Alberta. Waste liquids consisting of contaminated water, heavy oil, and fine-grained particulate matter are being diluted and injected under formation fracture pressures. Monitoring for environmental security and process control includes precision tiltmeters and comprehensive pressure analysis. Injectivity, transmissivity, reservoir pressure evolution, and fracture closure pressure calculations based on pressure fall-off and step-rate tests allow the formation state to be continuously re-evaluated. The reservoir is not being impaired by the continued injection of dirty liquids.

This article first describes Slurry Fracture Injection (SFI) history and principles, the site geology, and recompletion strategy. Then, data from the trial period and the summer operations are presented and analyzed. The use of SFI in this new application seems to be highly successful, and the nature of the process and controllable factors are discussed in the context of preserving target formation injectivity.

### Introduction

Slurry Fracture Injection (SFI) for waste solids disposal was developed over the last decade in Western Canada for the large volumes of sand produced along with heavy oil in the production process known as "Cold Production".<sup>1</sup> SFI is a variation of hydraulic fracturing with modifications to cope with requirements for episodic large-volume injection at

moderate rates for periods of months to years in the same well. A major aspect of SFI implementation is continuous monitoring to demonstrate containment and environmental security<sup>2</sup>; this has aided in approval by regulatory agencies in Alberta, Saskatchewan, and more recently in California. Monitoring is also used for process optimization, and allows the reservoir state to be carefully tracked during the process.

The first experimental SFI trial was executed in Saskatchewan by Mobil Canada at their Celtic Project in the years 1989-1990.<sup>3</sup> Over a period of several years they injected  $\approx 10,000 \text{ m}^3$  of fine-grained produced sand as a diluted aqueous slurry into a 35 m thick unconsolidated quartzose sandstone at a depth of 690 m. The target formation was an oil-free sand with 1-4 Darcy permeability, and injection took place at about the third point from the base. This experiment showed that formation injectivity to a sand-water slurry could be re-established for an episodic injection strategy, providing that the injection well was properly operated.

The SFI approach was accepted for produced sand by the Alberta Energy and Utilities Board during the period 1993-95, and five sand disposal projects have taken place since then, with several more having recently been approved. The waste injected at these sites is a fine-grained sand contaminated with 1-4% (weight percent) of viscous, asphaltene-rich heavy oil.

On three projects, it was necessary to cope not only with sand and the waste water used for making the slurry, but also with two materials known locally as "gorg" and "slops".

On the Celtic Project, the gorg was a stable emulsion of variable composition generated during heavy oil (9-18°API) exploitation using the Cold Production technique.<sup>1</sup> It is composed of  $\approx 40-85\% \text{ H}_2\text{O}$ , a few percent of fine-grained silicate minerals (clays,  $\text{SiO}_2$ , etc.), and an asphaltene-rich fraction of the heavy oil being produced. Chemical or thermal breaking proved difficult and costly, therefore disposal by SFI was considered. Inclusion of large quantities of gorg in the slurry and injection at typical SFI rates of 0.8-1.5  $\text{m}^3/\text{min}$  caused problems in the target formation, and in one case even generated small pressure responses in monitoring wells (from an abandoned heavy oil field) 90 m above the 690 m deep injection point. This implied that gorg was "sealing" the permeability, allowing fractures to propagate vertically

through 90 m (Fig. 1). This was surprising, considering that fractures had to transit over 20 m of 1-4 Darcy water sand and 70 m of stratified silty sediments with occasional permeable streaks to cause such a response. When gorp injection was deliberately reduced to a small fraction of the sand or ceased altogether, pressure responses at higher elevations ceased immediately.

A second SFI project was conducted in the Cold Lake region at 390 m depth in 1994-1995. Attempts to directly inject 150-200 m<sup>3</sup>/day of gorp resulted in formation pressurization, including substantial pressure responses at several near-by monitoring wells. In this case, the target stratum was a fine-grained 17 m depleted heavy oil sand with an original porosity of 31% and an average permeability of 1-2 Darcy. The injection and monitoring wells were production wells converted from the previous steam injection pilot. After operational modifications involving careful management of the viscous oil-rich gorp wastes, successful SFI without reservoir impairment or out-of-zone fracture communication was achieved. The monitoring strategy (Fig. 2) in this case used various surface pressure, density and rate measures, 10 precision surface tiltmeters<sup>4</sup>, and downhole pressure gauges in the injection and four monitoring wells.

On the third SFI operation, in 1995 in the Cold Lake region, instead of straight sand and waste water, much of the waste material consisted of a dirty slurry called "slops", a mix of sand and soil, waste oil, ground surface debris, and water. Slops are generated by tank bottom clean-out or during ground clean-up operations and contain naturally occurring iron sulfides, asphaltenes, and clays, making phase separation difficult and costly. The slops were disposed directly by SFI after additional dilution with water and through slow incorporation into the waste sand/water stream. In this case, wastes were managed correctly from the beginning, and no reservoir impairment was observed. Slop concentrations and injection cycle timing were adjusted to obtain this result.

A fourth SFI project is being carried out in the North Bodo Area of east-central Alberta (53°N, just west of the Saskatchewan border). Limited injected of about 3700 m<sup>3</sup> of slops on a trial basis in 1993-95 showed the feasibility of an SFI approach. The operator and Terralog Technologies Inc. designed and placed into operation an automated, remote-controlled slops injection facility in 1996, originally approved for injection of 16,000 m<sup>3</sup> of slops diluted by produced water at a rate of about 700 m<sup>3</sup>/month. The well has been quite successful. The article will focus on design parameters of this operation with typical analyses and pressure-time responses for the initial SFI period from April to September of 1996.

### Slurry Fracture Injection Methodology

In order to understand the approach evolved for slops injection, a review of the general approach to SFI is warranted. SFI preferably takes place in a high permeability zone of a horizontally stratified sandstone-shale sequence

(Fig. 1). The reasons are the following:

1. Fluid bleed-off is rapid, allowing reservoir pressure decay and strain relaxation between injection episodes;
2. A large target stratum lateral extent assures the necessary reservoir storativity to accommodate fluids;
3. Low permeability overburden (ductile shale) provides environmental security for surface waters;
4. Solid wastes remain close to the injection point because of the high permeability induced fracture bleed-off; and,
5. An unconsolidated stratum means that SFI can be re-initiated after shut-down periods and unimpaired formation accessed for the new SFI episode.

Massive waste injection into thick shale sequences is ill-advised because of low bleed-off rate, long distance uncontrolled fracture travel, and inevitable (and undesirable) pressurization of a large volume of the shale, leading to formation slip and attendant problems. Anecdotally (i.e.: no documentation which can be referenced), massive cuttings injection through casing annuli into shales has caused occasional casing impairment as well as waste fluid blowouts when the zone was traversed during later drilling operations.

Figure 3 shows a typical injection-repose sequence for SFI of a sand-water slurry into an unconsolidated sandstone reservoir at a depth of 500 m. A 24-hr cycle is usually followed, and the process is characterized by the following stages:

- A: Initiate clear water injection under fracture pressure
- B: Breakdown achieved and fracture is generated
- C: Clear water injection builds rate and momentum
- D: The sand content is gradually increased
- E: Continuous SFI operations continue for many hours
- F: The sand content is gradually decreased
- G: Clear water is post-flushed, followed by pressure shut-in
- H: Very rapid pressure drop to closure takes place
- I: The first decay flow regime terminates by a slope change
- J: The second post-SFI pressure decline regime continues

This SFI sequence is repeated day-after-day in the same well, monitoring various factors to guarantee that the formation is not being impaired and that the environmental security of the process is assured (i.e., containment is demonstrated).

### Monitoring the SFI Process

Monitoring involves three aspects: active monitoring of injection parameters to document and control the SFI process during injection; monitoring and testing reservoir response to determine reservoir parameters and potential impairment; and, remote monitoring of reservoir response through adjacent wells, the surface deformation field, and other methods such as microseismic monitoring.

The reservoir is geologically and hydraulically evaluated before SFI. The site must be geologically suitable with sufficient injectivity, transmissivity, and storativity to accommodate the fluid and solid volumes to be injected.

Typically, 5-10 Darcy-metres is considered a minimum for several weeks of daily 8-hr SFI injection episodes at 0.7-1.5 m<sup>3</sup>/min of 1.12-1.20 g/cm<sup>3</sup> fine-grained sand and waste water slurry. This is verified using standard well-test procedures in the re-completed cased hole, usually an abandoned producer. For slow rate injection of slops which contain far lower solids contents, we now understand that substantially different reservoir conditions can be accepted.

Before SFI, a step-rate test is used to evaluate formation fracture pressure to verify reservoir parameters and to test the downhole pressure gauges, the tilt-meters, and the surface metering equipment. Fig. 4 shows a typical example from the third project in the Cold Lake area (described earlier), conducted at a depth of 360-370 m using injection rates from 0.25 to 2.0 m<sup>3</sup>/min, maintaining each rate for 30 min. This clear-water injection took place after ≈500 m<sup>3</sup> of sand and slops had already been injected in the well, and therefore the gross fracture extension pressure of 7.45 MPa BHP reflects in part the stress changes imposed by the solids injection, as well as perforation and near wellbore pressure losses. At this stage, dominant fracture orientation was horizontal, whereas initially it was vertical. In other words, lateral stresses are increased by SFI operations, something we observe at all sites if large sand volumes are disposed.

SFI surface metering equipment includes transducers for pressures and volume rates, pump parameters, and slurry exit density for mix tank control of injection solids content. Well-head pressure, flow-line pressure, casing annulus pressure (between the tubing and the production casing) and bottom-hole pressure in the tubing (BHP) are continuously monitored to determine well parameters, injection behavior, and post-SFI pressure decay to re-calculate reservoir parameters after injection episodes.

Fig. 5 shows a 24-hour pressure-time SFI cycle for the same Cold Lake well as Fig. 4. For fracture initiation, the injection rate is set at a specific value to guarantee fracture development. The pressure increase rate is monitored (as in the step-rate test) to make sure the perforations are not blocked and that there has not been a massive change in the ability of the formation to accept fluids. After the SFI cycle is finished and the clear water post-flush complete, the pressure decay curve is recorded and then analyzed to give fracture closure pressure and reservoir transmissivity. The example chosen shows two separate flow regimes after fracture closure, demonstrating a response similar to the flow regimes observed in horizontal well testing.<sup>5</sup>

The issues of waste containment in the target zone and the ability of the reservoir to keep taking fluids and solids without serious impairment are addressed repeatedly during SFI operations through the pressure responses and analyses of reservoir condition, combined with offset well data, deformation analyses, and, if available, microseismic data.

If adjacent or shallower wells are available or are stipulated in the regulatory agreement, they are monitored

continuously with down-hole pressure gauges.

Physical solids containment in the reservoir is confirmed by various methods. Mathematical inversion of surface tiltmeter data permits spatial reconstruction of the volumetric deformation in the reservoir. Estimates of fracture orientation, radial extent and vertical thickness are made based on pressure response and deformation data. If more precision is needed on specific containment geometry, active microseismic monitoring of acoustic emissions during and after injection can delineate the extent of the zone.

### Site and Geology

The injection site is just west of the Saskatchewan border near the Town of Provost, Alberta. The chosen formation for slops disposal is the oil-bearing McLaren Formation channel sand of Cretaceous age. It is one of the uppermost of the Mannville Group sequence of blanket and channel sands which are hydrocarbon targets (heavy oil and gas) in a region stretching from southeast Alberta and southwest Saskatchewan 700 km north to the Athabasca Oil Sands.<sup>6</sup> The channel is bounded by shales, and the nearest active producing well is 1600 m distant. Figure 6 is a schematic of the well, along with the geological names of the strata.

The Colorado Group from 454 to 717 m is almost entirely a smectite-rich ductile shale of extremely low permeability. Nowhere in the region are the strata significantly folded or transected by faults, therefore this ductile shale is an ideal regional seal against upward movement of formation or injected water. The Mannville Group at this site is 115 m thick (717 to 833 m), and consists of shaley sands and silts, silts, shales, and an occasional clean sand bed or channel. Mannville strata are largely uncemented, and clean sands tend to have porosities of 27-30% at these depths. Below 833 m are thick, competent flat-lying Paleozoic carbonate strata.

The SFI target formation is a 27% porosity north-south trending channel sand approximately 5-6 m thick having an estimated permeability to injection of water of 500 mD. The sand is fine-grained to very fine-grained (60-120 μm), well-sorted, subangular and unconsolidated, with a trace of carbonaceous material. The sand is mainly quartz, and is geochemically stable with respect to the fluids to be injected.

The SFI stratum contains heavy oil ( $S_o \approx 70\%$ ) and is being actively produced about 1.6 km away, to the north. However, this well had been scheduled for abandonment before deciding to convert it to a waste injection well. Based on an assessment by the oil company engineers, it was determined that the disposal of "slop", if anything, should support production drive mechanisms for any offsetting wells.

### Well Recompletion and SFI Operation

The SFI well for this project has a 244.5 mm surface casing and shoe at 107 m depth KB, and a 177.8 mm production casing set at a depth of 855 m. Both casing strings are cemented to surface, standard practice in Alberta to protect

shallow potable water zones. The casing had been plugged back with cement to about 830 m.

The 3 m perforated interval is at 745.5-748.5 m, at the top of the McLaren Formation channel structure. A shot density of 39 shots per metre gave 120 perforation openings with an area of perhaps 300 cm<sup>2</sup> (=40 square inches).

Injection tubing of 73 mm diameter was installed with the production casing packed off above the perforations. The annulus was tested at a surface pressure of 12 MPa for 15 min to confirm full pressure integrity. A new well-head rated at 14 MPa minimum was installed, then 30 m<sup>3</sup> of water at 70°C were injected at a rate of 0.4 m<sup>3</sup>/min at a WHP less than 7.0 MPa. Repeated temperature logging was carried out, and a cement bond log was also performed. These tests confirmed that the McLaren sand channel was hydraulically isolated and that there was no detectable leakage behind the casing.

The tubing was withdrawn and fully inspected, then re-installed with a pressure gauge communicating with the production tubing interior just above the hydraulic packer. The transducer was linked to surface by a continuous shielded armored cable in the annulus, which was displaced with corrosion-inhibiting fluid before setting the packer above the perforations at 735 m. The 50 m below the perforations (750-800 m) had been confirmed as fully open and clean during the workover activity, and this open production casing was intended to act as a sump for the slop injection process. The completed well is shown in Figure 12.

A step-rate injection test was carried out (Table 1), giving data on formation injectivity. The step-rate test used produced formation water at a temperature of 40°C and an assumed density of 1.04 g/cm<sup>3</sup>. Step rate data analysis using various plots and derivative plots indicated that a short-radius vertical fracture developed in order to achieve the volume rates used. The BHP fracture closure pressure was estimated to be approximately 13 MPa, which corresponds to a gradient of 17.5 kPa/m at the injection depth of 745 m. It is thought that the least lateral stress in this region at 750 m depth is ≈80-90% of overburden. Overburden stress gradient is estimated at about 22 kPa/m, therefore the predicted fracture gradient was about 17.5-19.5 kPa/m. The step-rate test thus confirmed that the actual value is at the lower end of this range. It also showed that vertical fracturing took place to achieve the desired rates, which were determined to be 40 litres/minute of slops-water mixture.

Regulatory permission was granted to carry out injection of a diluted slops mixture, with an upper limit on the surface pressure (WHP) of no greater than 8.0 MPa, which corresponds to a gradient of 20.9 kPa/m. This implies that maximum injection pressure is above the fracture gradient, but below the value required to propagate large horizontal fractures, which would be > 22 kPa/m.

The average composition of the slop material to be disposed is 30-50% formation water, 50-60% heavy oil of 12°API gravity, and 3-9% solids, generally fine-grained

mineral matter. The slops are diluted by adding approximately twice the volume of waste produced water which contains the following dissolved cation concentrations: 9200-9600 mg/l Na<sup>+</sup>; 237-250 mg/l Ca<sup>++</sup>; 90-120 mg/l K<sup>+</sup>; and, 150 mg/l Mg<sup>++</sup>. The nature of the *in situ* formation water in the McLaren Formation is similar: it is an ancient brine that is not suitable for commercial use nor human consumption.

### SFI Initialization

The first active injection period took place from April 22 to May 15, 1996. In this period, 155 m<sup>3</sup> of slops were injected, diluted with formation water to a total volume of 512 m<sup>3</sup>. Typical injection periods were 12 hours long, followed by a clear water post-flush of 2 hours, then 10 hours of shut-in and continuous pressure monitoring. The injection rates chosen based on the step-rate test (Table 1) averaged about 0.040 m<sup>3</sup>/min (40 litres per minute) for this testing period. The density of the injected slurry varied between 1.02 and 1.08 g/cm<sup>3</sup>.

Before and during SFI operations, the "far-field" reservoir pressure at the distance of influence was determined by extrapolation to be 11.7 to 12.9 MPa. The normal hydrostatic value at this depth should be about 7.5 MPa; the higher pressures reflect the previous slops trial injection from 1993 to 1995, water injection during re-completion and testing, step-rate test injection, and perhaps even some off-set production activity. If the entire region were left totally inactive, the hydrostat would be approached, but only after many years because of the high oil saturation, the fine-grained nature of the reservoir, and the sealed nature of the McLaren channel.

The maximum SFI BHP for cycles in this period was from 13.1 to 13.8 MPa. These values also correspond well to the calculated fracture extension pressures from the step-rate tests. After shut-in, pressure declined slowly, but there was little to no continued formation pressure build-up detected between cycles. BHP values for the end of the shut-in cycles were in general no higher than 12.8 MPa. On April 26, a large slop slug was injected, and the long-term shut-in BHP was 13.0 MPa, indicating that around the perforations, the BHP remained close to the fracture initiation pressure. Slow pressure drop-off confirms that when there is no open fracture. The pore throats in the reservoir are sufficiently blocked by the *in situ* oil and by the injected slops oil that pressure decay to the far-field is slow.

Some of the details of April-May injection are given in Table 2. The BHP values are, respectively, the peak value during continuous SFI, and the value at the end of the shut-in period, which was generally 10 hours long. No slop was injected in the period May 06-09, only waste water, and lower shut-in values were observed, 12.3-12.4 MPa.

Pressure drop-off data during shut-in periods were analyzed to estimate formation transmissivity and fracture

closure stress, using logarithm of time and derivative plots. Figs. 7 and 8 show typical plots for the April 28 pressure drop-off period. The slope of the straight line in Fig. 7 determines transmissivity, and the vertical lines in Fig. 8 bracket estimated closure pressure. (Note that the vast majority of the individual data points are left off for clarity.) Table 3 contains results of some of the analyses carried out over this period. The data in this Table and in the previous one show that there is no permanent formation blockage or alterations of fracture closure stresses taking place as the result of the introduction of substantial volumes of slop (155 m<sup>3</sup>) into the relatively thin, oil-bearing SFI stratum. The drop-off data from May 07 were obtained after two days of clear water injection (no slops) and show that formation transmissivity is essentially unchanged. A slight drop in fracture closure pressure is noted, reflecting the absence of solids and oil in the 70.94 m<sup>3</sup> injected during these two days.

Missing data and changes in the slop-water ratios during this SFI test period arose as the automatic injection system was being calibrated and debugged.

These data, and other analyses carried out on pressure build-up, showed that the typical pressure-time response for slow slops injection into an oil-bearing formation is very different than those previously experienced in SFI operations in oil-free or depleted reservoirs (projects one to three). The differences are contrasted in Table 4, where "typical" data from a high-rate, high-solids-content operation are compared to the data from this low-rate slops injection case.

Importantly, the trial period confirmed that slops could be successfully disposed using the SFI approach, without impairing the reservoir. This issue is discussed again at the end of the article.

### Full-scale SFI operation, summer of 1996

After design changes on the automatic control and metering systems for the remote-controlled slops SFI well were implemented, a period of largely continuous injection cycles took place between May and the middle of September, 1996. In this period, there were further shut-downs for repairs, for long-term pressure shut-in data collection, and for optimizing the automatic system control parameters. About 2500 m<sup>3</sup> of total fluids consisting of about 1000 m<sup>3</sup> of slops and 1500 m<sup>3</sup> of waste water were episodically injected using the same approach as before. By the end of September, 1543 m<sup>3</sup> of slops and 2368 m<sup>3</sup> of waste water had been cumulatively injected in the disposal well, for a total of 3911 m<sup>3</sup> fluids since the beginning of the use of this well.

Fig. 9 shows the history of injection and the reservoir response over the period May 23 to September 11, 1996. For brevity, detailed tabular data are not provided as for the previous period. Fig. 10 is a long-term pressure drop-off test conducted at the end of this period (Sep. 11-19), and Figure 11 contains the continuous trace of bottom-hole pressures for five sequential and typical slops/water SFI injection cycles in

early September. This curve should be contrasted with the typical sand/water SFI plots in Figs. 3 and 5, keeping in mind the substantial differences between the two SFI approaches, listed in Table 4.

The bottom axis of Fig. 9 consists of calendar dates and is not a linear scale, as periods of shut-down are excluded, and, toward the end of the period, the dates are intermittently plotted. The slops volumes and the total volumes (cumulative in both cases) are plotted as curves to be read off the right-hand axis in cubic metres.

The top two traces are the BHP values for the maximum SFI pressure during active injection (points C, Fig. 11) and the minimum fall-off pressure (points A, Fig. 11) respectively; the latter is always lower than the former because of formation bleed-off of the pressurized region around the injection area during the pressure decay period. A gradual increase in the maximum SFI pressure from 13.2 to 14.6 MPa (17.8 to 19.7 kPa/m in terms of fracture gradient) took place from May to June. This indicates that the fracture initiation and propagation stress increased in the SFI target stratum. One would expect a gradual rise in fracture pressure from both the solids input and the pressure increase effects (the reverse of a depletion effect). However, after the peak was reached in June, it did not increase for the remainder of the period. In fact, during the August-September period, where there were more periods with no injection, the formation stresses relaxed substantially, and the maximum SFI BHP reverted back to the range of 13.4-13.8 MPa, as for the April-May period.

The minimum fall-off BHP approximately tracked the maximum SFI BHP with a difference of 1.0 to 1.6 MPa, in a manner similar to the April-May SFI trial period. After values of ≈13.0 MPa during the Aug.-Sept period, the minimum decay BHP reverted to 12.2-13.0 MPa, similar to the values during the April-May injection trials. There is no convincing evidence of general reservoir pressurization taking place, although pressures around the SFI wellbore are maintained in an elevated state for a long time after shut-in because of the pore blockage and generally low permeability.

The relative transmissivities are also plotted as the last curve on Fig. 9, solely to show their evolution. There is some evidence for a decline in reservoir transmissivity for the period reported, with values of 150-500 mD-m/MPa-s for the period June 24 to Sept 11. However, it must be noted that with these modest pressure decay responses and substantial scatter of the plotted points, choosing a tangent to a straight line portion, as shown in Fig. 7, is fraught with error. However, the relative formation injectivity analyses plotted on the same figure show no decline, indicating that the formation remains capable of taking 40 l/min of slops/water mix on 24-hour cyclic SFI injection. The steady maintenance of reservoir parameters (no fluctuations), is evidence for containment because communication with upper zones would lead to large formation flow parameter changes.

An extended eight-day pressure fall-off test data set was available after September 11 because of equipment repairs (Fig. 10). Data analysis indicates that early post-SFI pressure decline is dominated by a fracture-like planar shape which provides access to regions of generally higher permeability, but located away from the wellbore. The second part of the pressure fall-off is exceedingly slow and approaches (but does not fully attain) a shape characteristic of radial flow in a region with generally low permeability. This behavior will be discussed in the mechanisms section, but a major conclusion is that such data do not reflect correctly the formation far-field properties, but remain dominated by the altered region around the wellbore.

Fracture closure pressure analyses carried out on the pressure decay data in the Aug.-Sept. period gave values of 12.5 to 12.9 MPa, slightly less than the April-May period, again confirming that the reservoir was neither being seriously impaired nor stressed to the point where horizontal fracturing would take place, as is common in conventional SFI with large amounts of fine-grained sand.

Tiltmeter data will not be discussed in this article, except to comment that vertical fracturing of very limited extent was indicated.

### Physical Mechanisms During Slops Injection

Slops contain heavy oil and fine-grained solid matter; therefore, pore throat blockage and reduced injectivity in the wellbore vicinity would be expected. However, injection in this project was into a fine-grained sand which already contained large quantities of heavy oil (12°API), so any impairment effect is difficult to identify. The following facts are known, based on various analyses and lines of evidence:

- Fractures are consistently vertical and of limited extent.
- Formation ability to accept slops (injectivity) remains intact, even after >1200 m<sup>3</sup> of slops have been injected.
- Fracture initiation and propagation pressures (peak SFI BHP values), as well as minimum drop-off pressures, remains essentially unaltered, despite the substantial amounts of solids introduced into the formation.
- Specific values of fracture pressure and minimum drop-off pressure may show a slight tendency to rise with continuous SFI episodes, but definitely show a tendency to drop to original values (step-rate test data) during prolonged shut-down periods.
- Transmissivity around the wellbore, based on the slope of the early-time drop-off curves, seems to have declined over the slops SFI period.
- Pressure drop-off analyses suggest that decay response is because of access to a high permeability planar zone, followed by a slow approach to radial flow.

Figure 13 shows what we believe is taking place during each SFI episode. This episodic process can be explained in the following steps:

- A permeability-impaired zone is generated and grows around the wellbore because of retention of the oil phase of the slops-water injection mixture, combined with the slow expulsion of the more mobile phase (water).
- Each SFI cycle initiates a vertical fracture which propagates laterally from the wellbore.
- These fractures rapidly extend beyond the permeability-impaired zone, and essentially all of the newly injected material is carried far from the near well-bore zone.
- When slops injection is stopped, the clear water phase flushes the open fracture zone, and perhaps a few grain diameters on either side, free of fine-grained solids and heavy oil, generating a temporary zone of permeability higher than the near-wellbore, lower permeability zone.
- After shut-in, pressure access exists along the flushed zone, resulting in planar flow connecting to the higher permeability region beyond the tips of the fracture.
- As pressure decays, this zone is gradually plugged by water expulsion and slow movement of heavy oil and fines; flow now becomes dominated by the effect of the permeability impaired region near the wellbore.
- Stresses are not being built up because each SFI episode deposits the new solids farther and farther from the well bore, and because there is no permanent reservoir pressurization beyond the current value.

### Closure

It has proven possible to modify the slurry fracture injection approach for solids disposal to accommodate dirty, oily water (slops) disposal in a thin oil-bearing fine-grained unconsolidated sand. In this case, it was demonstrated that fluids and solids containment in the target reservoir was being maintained, and it was also demonstrated that the slow slops SFI process took place without reservoir impairment. Careful monitoring and planning has been essential to this development, and systematic analysis of pressure response allows the reservoir evolution to be successfully tracked

### References

1. Dusseault M.B., Geilkman, M.B. Roggensack, W.D. Practical requirements for sand production implementation in heavy oil. SPE #30250 (1995).
2. Dusseault M.B., Bilak R.A. & Rothenburg L. Inversion of Surface Displacement to Monitor In-Situ Processes. Int. J. Rock Mechanics, Mineral Sciences and Geomechanics Abstracts, 30, 7 (1993), 1219-1222.
3. Cole, C.W. and Black, R.W. Design criteria for produced sand injection facilities. U. of Calgary Heavy Oil Technical Symposium, Challenges and Innovations, Calgary, AB, (March, 1990).
4. Rothenburg, L., Dusseault, M.B., Bilak, R.A. and Bruno, M.S. Waste disposal monitoring using the surface displacement field. Proc. EUROCK '94, SPE-ISM Conf., (1994) 739-745.
5. Zhang, L. and Dusseault, M.B., 1996. Anisotropic permeability estimation by horizontal well tests. SPE Int. Conf. On Horizontal Well Technology, 18-20 Nov., Calgary AB, SPE #37071 (1996).

6. Dusseault M.B., Bilak R.A., Bruno M.S. & Rothenburg L.  
Disposal of Granular Solid Wastes in the Western Canadian  
Sedimentary Basin. Proc. Deep Well Injection Symposium.

Berkeley, CA., 1994, (published 1995).

Injection volume m <sup>3</sup>	Time min	Rate m <sup>3</sup> /min	Rate m <sup>3</sup> /day	WHP wellhead MPa	Water head MPa	Friction losses MPa	BHP bottom-hole MPa	Gradient kPa/m
0.0	5.0	0.0	0.0	6.1	7.578	0.0	13.678	18.4
1.0	22.0	0.0455	65.5	6.1	7.587	0.015	13.663	18.3
1.0	15.0	0.0667	96.0	6.1	7.578	0.022	13.657	18.3
1.27	15.0	0.0847	121.9	6.2	7.587	0.028	13.751	18.5
0.0	5.0	0.0	0.0	6.0	7.578	0.0	13.578	18.2

Table 1: Step-Rate Test to Determine Injection rates and Fracture Gradient in the Slops SFI Well 1

Day	Injected Volume m <sup>3</sup>	Injected Slop m <sup>3</sup>	Peak SFI BHP, MPa	Shut-in BHP, MPa
04/22	27.06	8.10	13.4	12.7
04/23	29.33	15.58	13.7	12.9
04/24	26.17	17.94	13.6	12.8
04/25	34.96	10.70	13.4	12.8
04/26	13.35	19.52	13.7	13.0
04/27	38.89	5.24	13.5	12.7
04/28	32.53	8.41	13.6	12.7
04/29	36.85	9.77	13.7	12.8
04/30	30.29	10.50	13.7	12.8
05/01	34.88	8.02	13.7	12.8
05/02	28.68	7.26	13.6	12.8
05/03	26.58	11.60	13.4	12.6
05/04	--	--	--	--
05/05	18.96	10.82	14.2	12.8
05/06	38.68	n/a	13.1	12.4
05/07	32.26	n/a	13.2	12.3
05/08	16.12	n/a	12.8	--
05/09	--	--	--	--
05/10	8.75	5.92	12.8	12.1
05/11	19.15	5.41	12.7	--
(12-14)	--	--	--	--
05/15		0.36	12.6	11.7
Totals	512.11	155.15	--	--

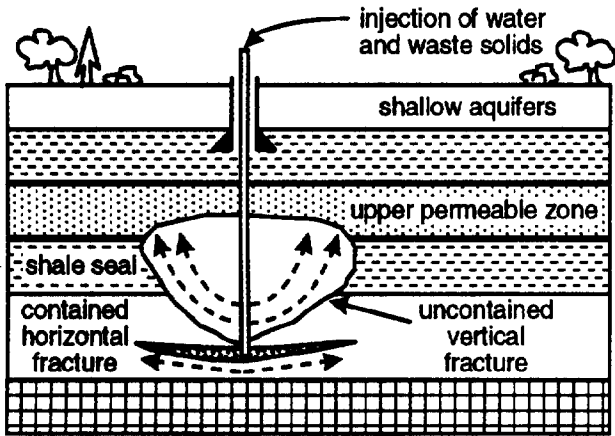
Table 2: Fluid Volumes and Peak SFI Pressures and Minimum Drop-Off Pressures, April 22-May 15, 1996

Day	Closure stress MPa	Transmissivity mD-ft
04/23 - 1996	13.03	617
04/25 - 1996	13.06	848
04/28 - 1996	12.97	969
05/02 - 1996	13.24	714
05/06 - 1996	13.00	870
05/07 - 1996	12.72	754

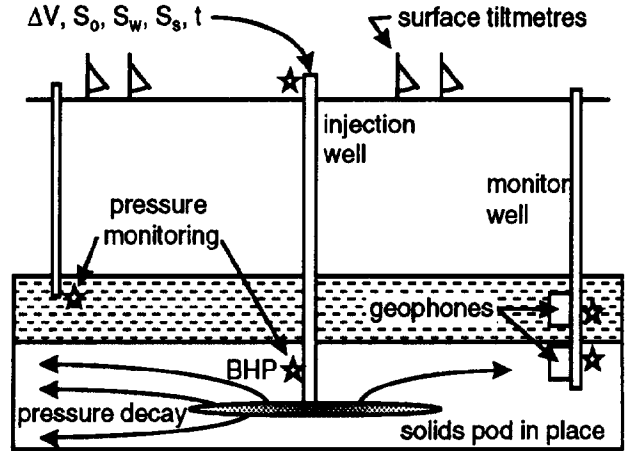
Table 3: Evolution of Closure Stress and transmissivity, April-May Trial Injection Period

Parameter	Typical SFI Cases	Slops SFI Case
Injection rate	0.75-1.5 m <sup>3</sup> /min	0.035-0.50 m <sup>3</sup> /min
Injection period	7-9 hours	12 hours
Flush period	10-20 min	120 min
Decay period	14-16 hours	10 hours
Strata thickness	10-35 m	5-6 m
Reservoir	Oil-free or depleted	Oil sat. (12°API)
Porosity	27-32%	27%
Flow capacity	>10 Darcy-m	<1 Darcy-m
Solids type	fn.-gr. oily sand	mostly silt to clay
Solids content	>10-15%, volume	<3% by volume
Oil percentage	<1-2% by volume	>10% by volume
Slurry density	1.1-1.22 g/cm <sup>3</sup>	1.03-1.07 g/cm <sup>3</sup>

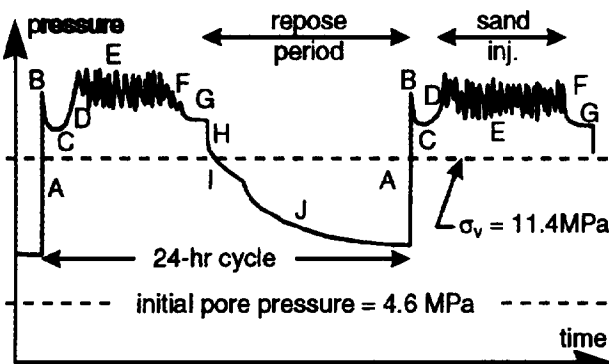
Table 4: Contrasting Conventional SFI with the Slow Slops SFI Case Discussed in this Article (the flow capacity data should be expressed in terms of units containing viscosity, but are shown as "relative" flow capacity units)



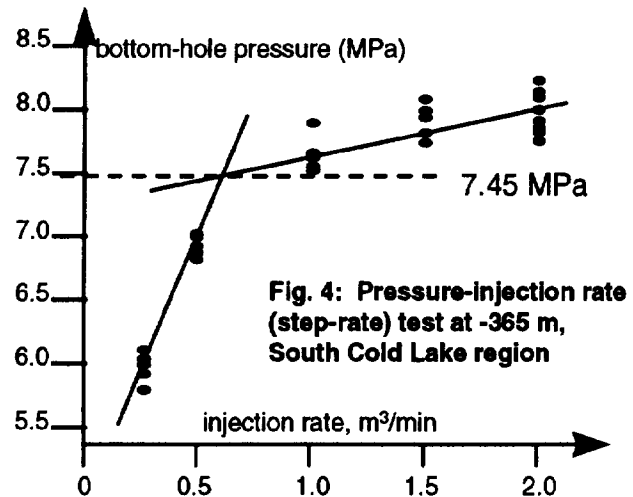
**Fig. 1: Slurry fracture injection solids containment by horizontal fracturing in a permeable formation. Vertical fracturing can lead to containment loss.**



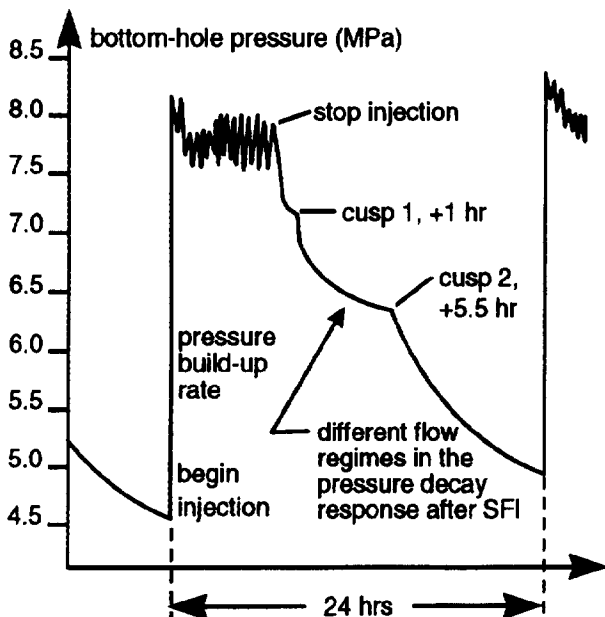
**Fig. 2: Monitoring SFI operations. Pressure sensors at bottom-hole, well-head, plus adjacent wells. Deformation data at surface, geophones, rates, etc.**



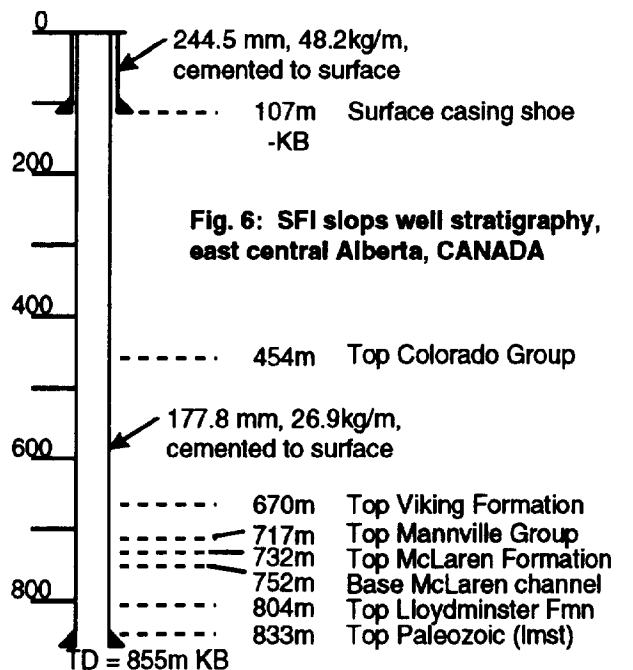
**Fig. 3: Typical SFI cycle pressure data for fine-grained sand and waste water slurry at 500 m depth. Letters refer to the SFI stages listed in the text.**



**Fig. 4: Pressure-injection rate (step-rate) test at -365 m, South Cold Lake region**



**Fig. 5: SFI cycle for the same case as Fig 4.**



**Fig. 6: SFI slops well stratigraphy, east central Alberta, CANADA**



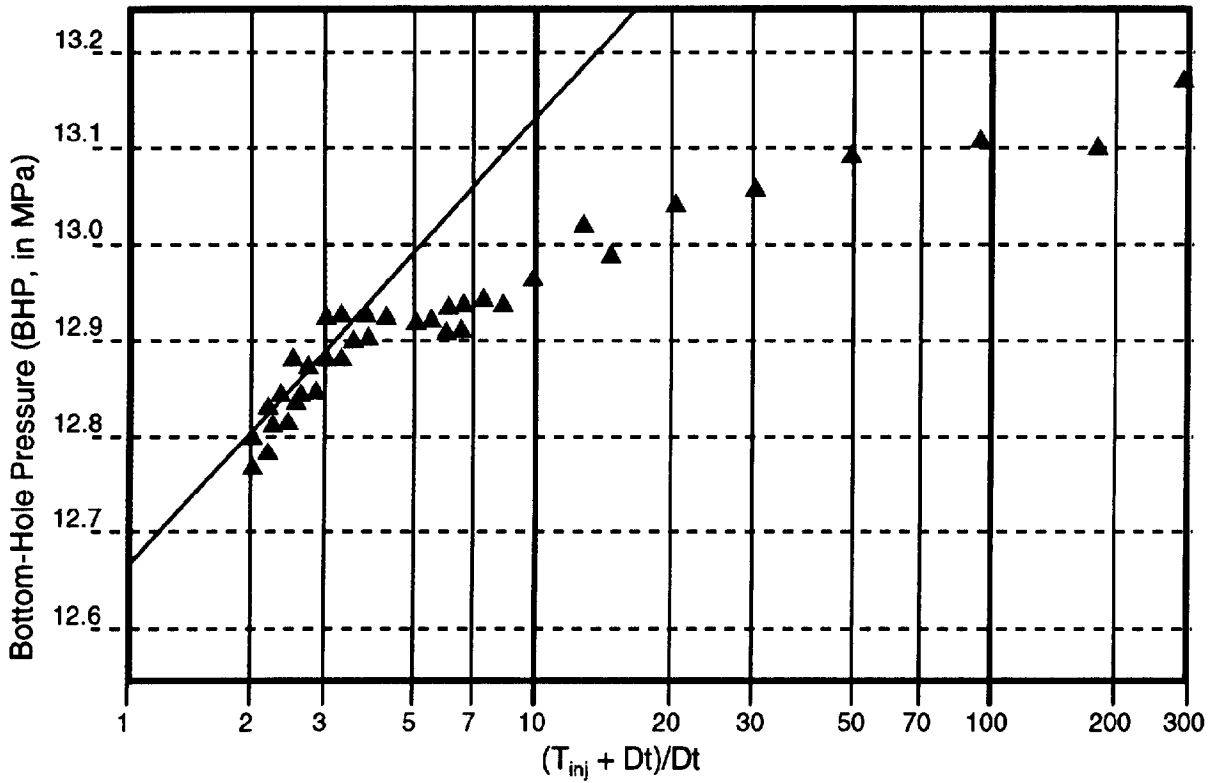


Fig. 7: Pressure - time plot to determine formation transmissivity, data from April 28 pressure decay

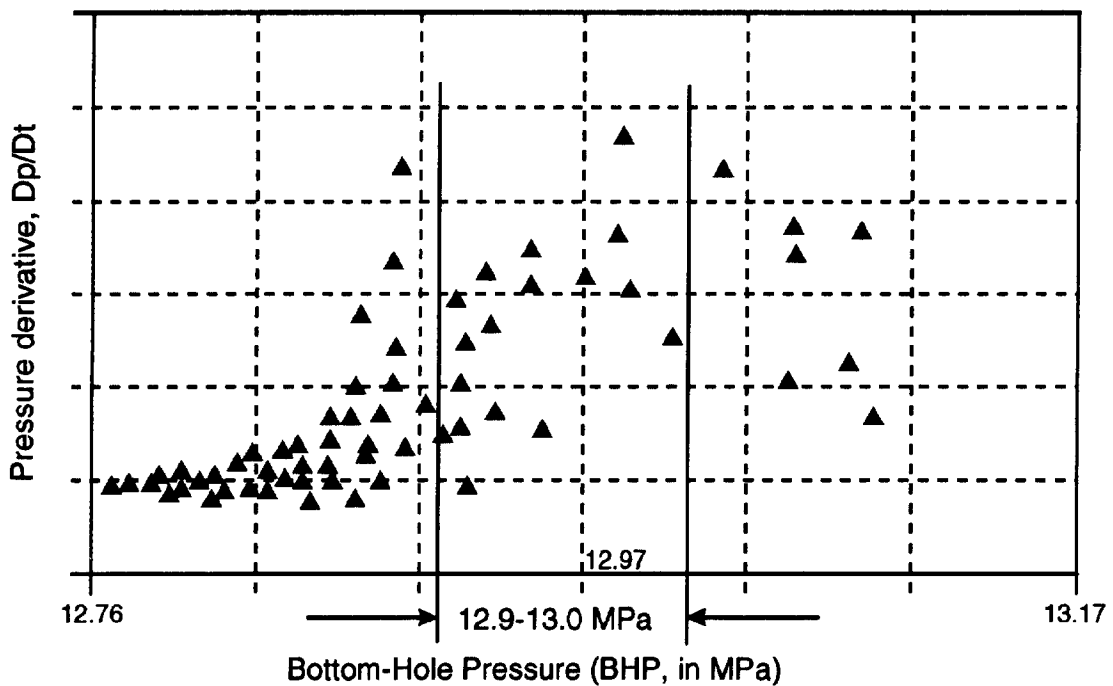
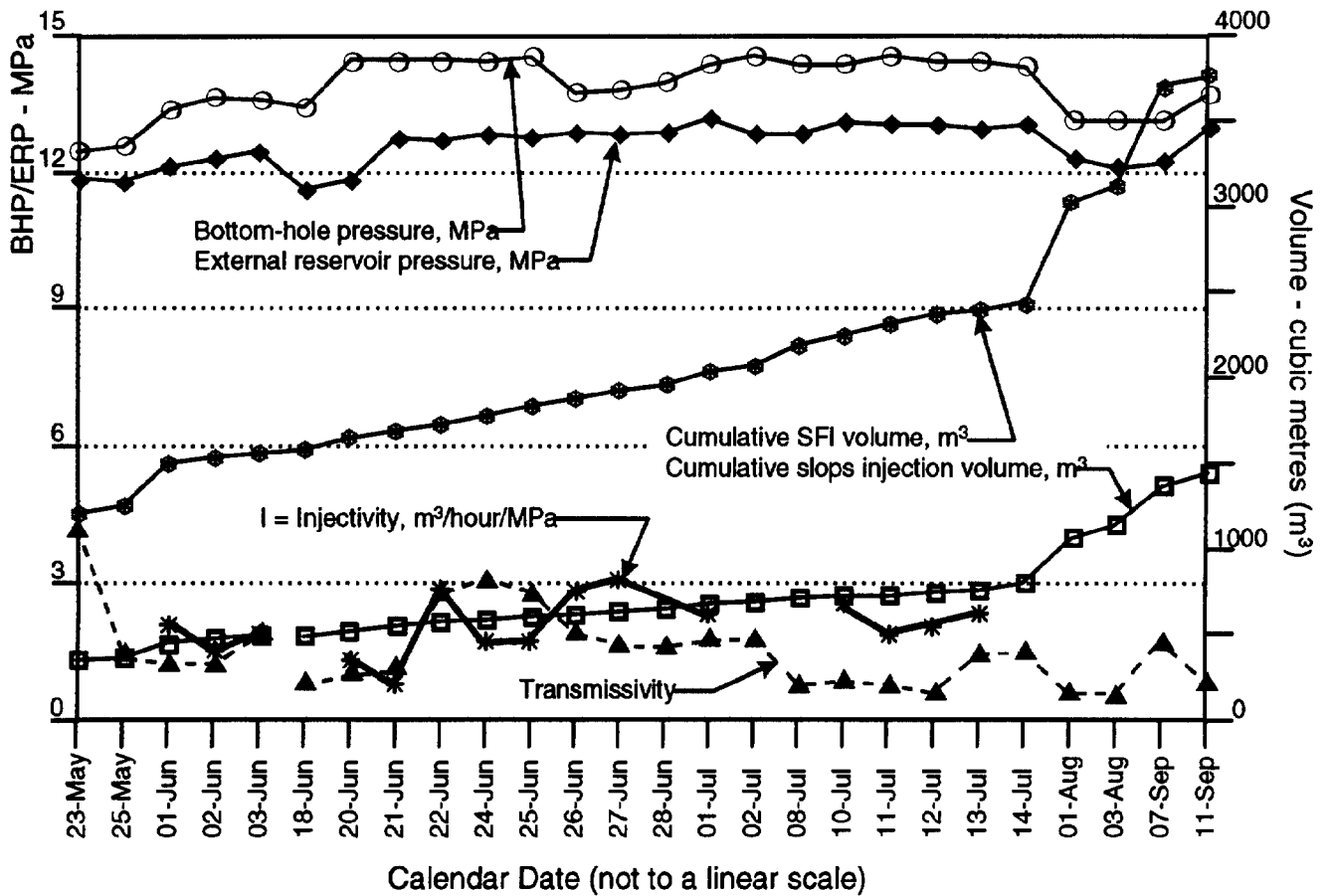


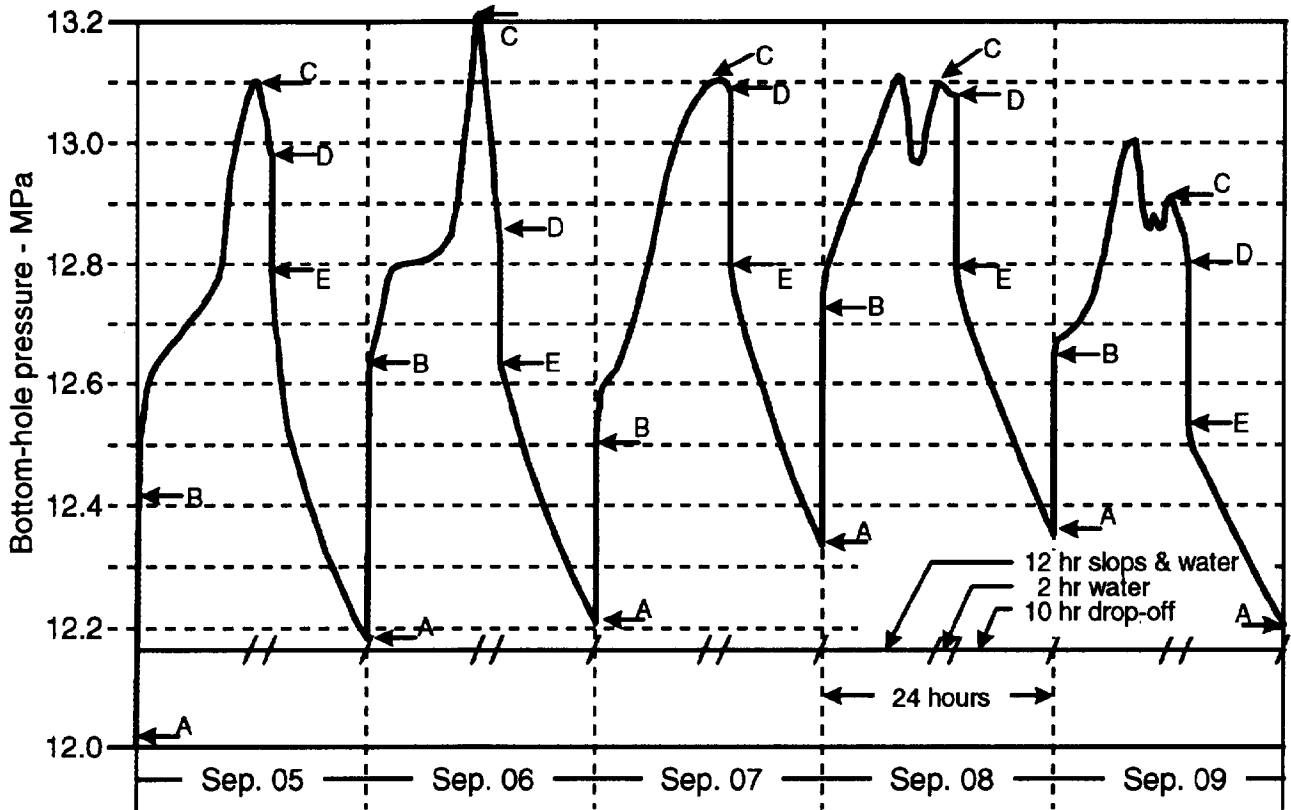
Fig. 8: Derivative pressure plot to estimate fracture closure pressure, April 28 pressure decay



**Fig. 9: Slops injection history for May 23 - September 11. Volumes on right-hand axis, pressures on left-hand axis. Transmissivity and injectivity scales are omitted, curves are included to show evolution.**

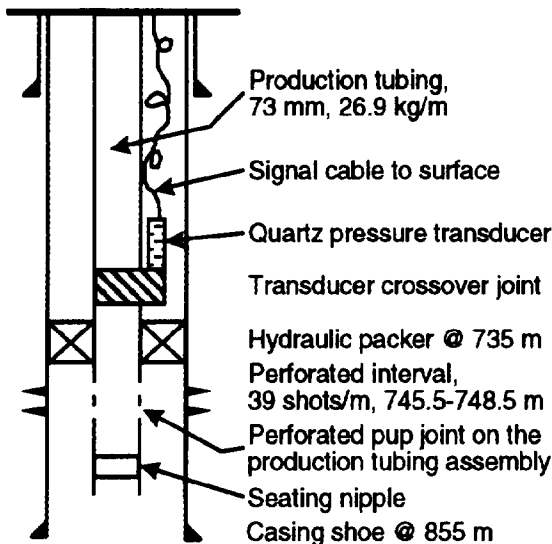


**Figure 10: Long-term pressure drop-off test on slops injection well**

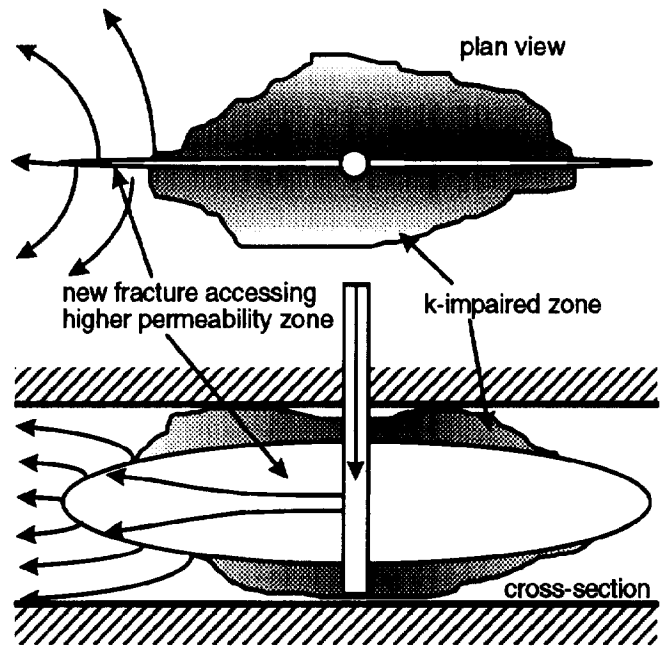


**Fig. 11: Bottom-hole pressure for five consecutive slop SFI and pressure fall-off cycles. A is end of drop-off cycle and start of injection; B is fracture initiation; C is cessation of slops injection and start of clear water, D is the point of shut-in, and E is the instantaneous pressure after shut-in, before fall-off begins. In each cycle, the highest point is the maximum SFI BHP, the lowest is the minimum fall-off BHP.**

**Completed Well Configuration**



**Fig. 12: Injection tubing string assembly**



**Fig.13: Fracture and flow mechanisms in slop injection**